

# BOX POST SVEZZAMENTO



**NOME PRODOTTO**  
Box Post Svezzamento

**CATEGORIA**  
Box Vitelli (relativa icona)

**SETTORE D'IMPIEGO**  
Ricovero dei vitelli fino a circa 6 mesi di vita circa

**PAESE DI PRODUZIONE**  
Italia

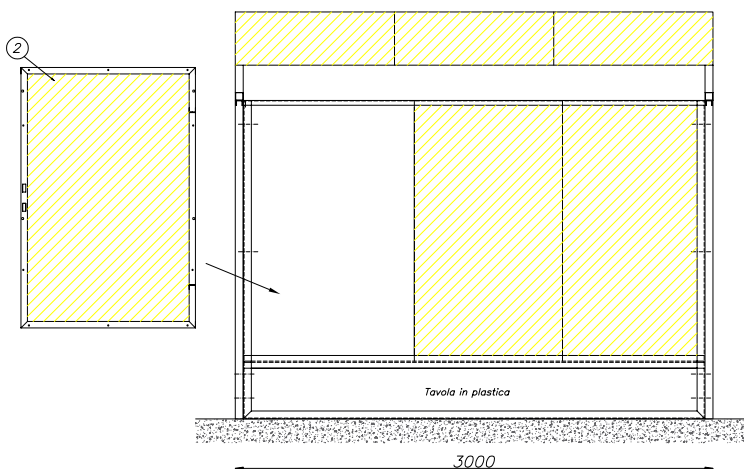
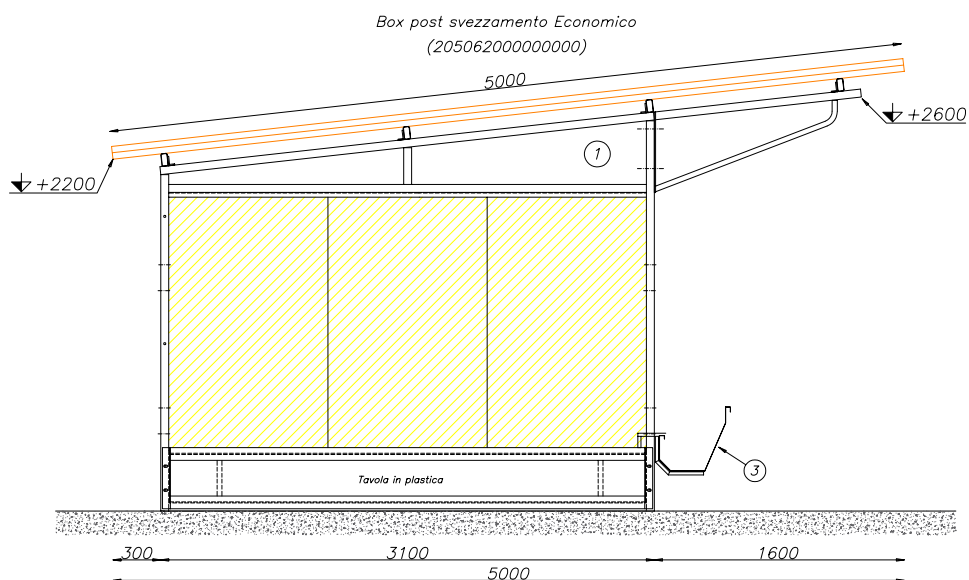

Posizione	Codice	Descrizione
01	205062000300320	Box 3.2x3m sporto anteriore 1.6m
02	205068000163109	Porta per box eco
03	205068000000300	Mangiatoia in Inox 3m

# BOX POST SVEZZAMENTO



Box post svezzamento Economico  
(20506200000000)

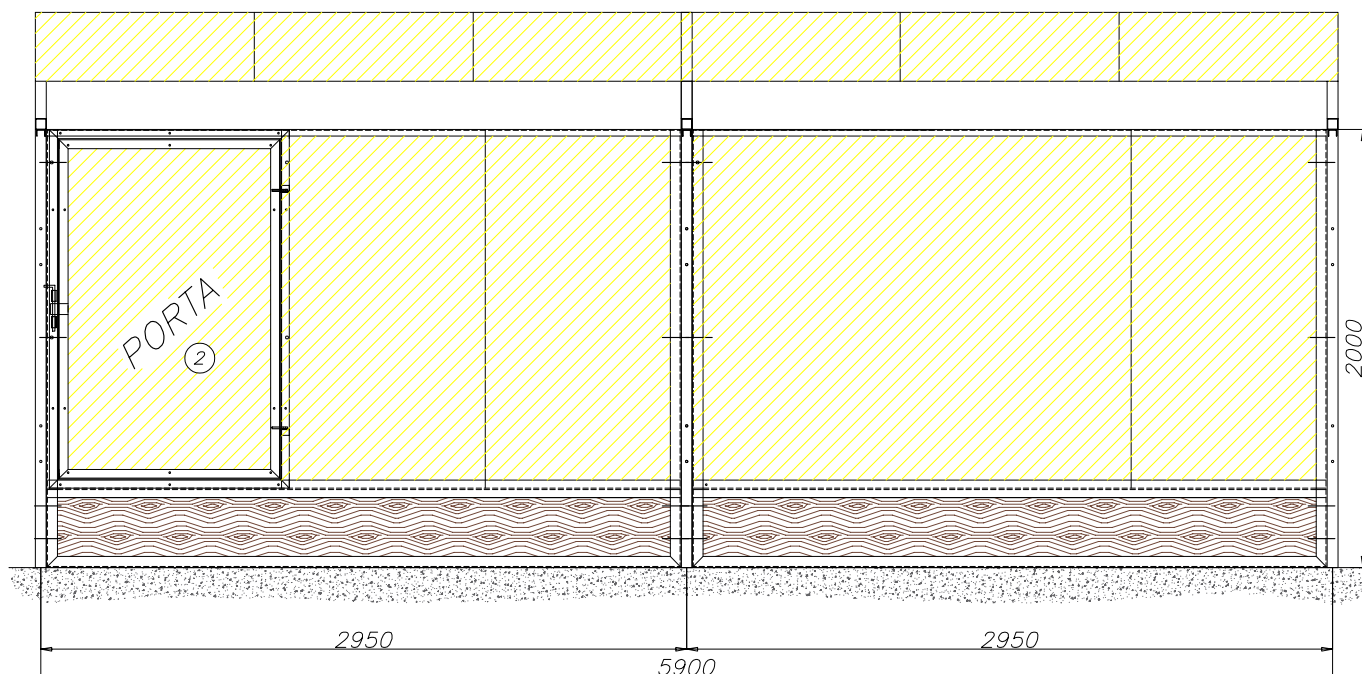
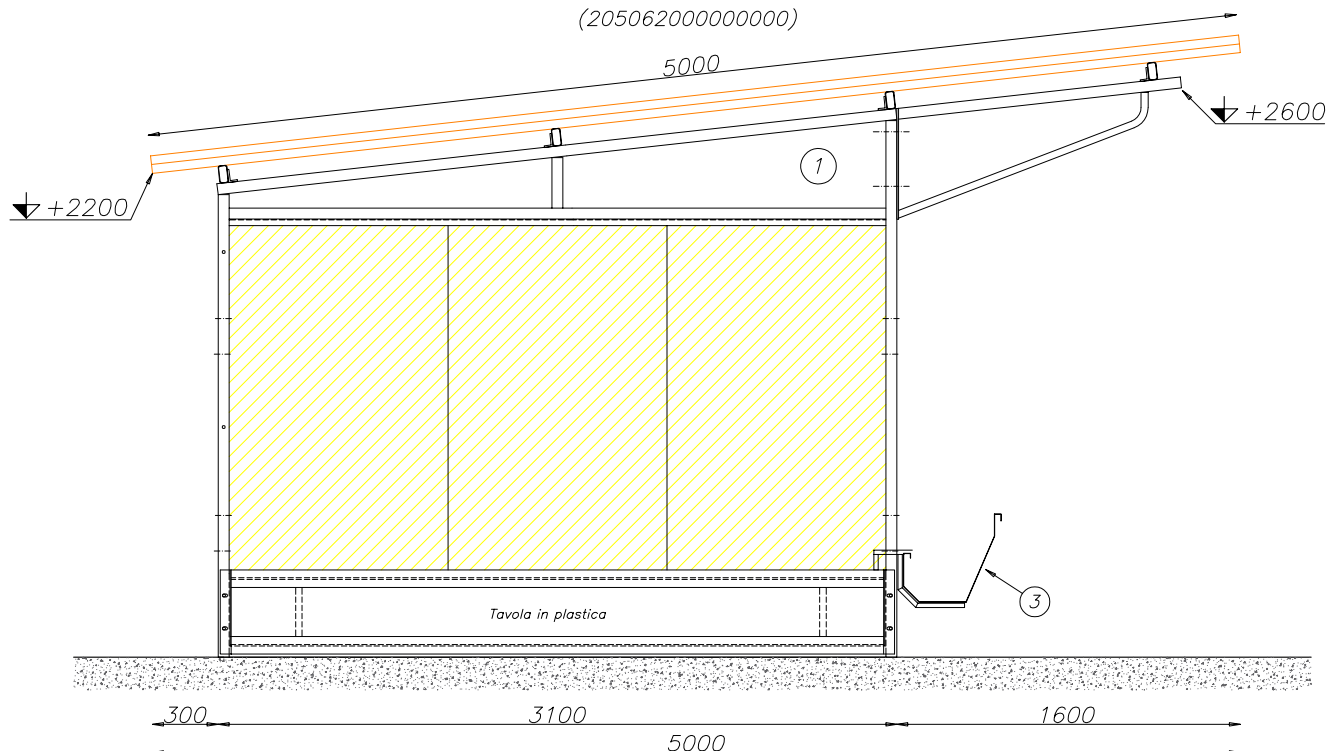

Posizione	Codice	Descrizione
01	205062000600320	Box 3.2x6m sporto anteriore 1.6m
02	205068000163109	Porta per box eco
03	205068000000300	Mangiatoia in Inox 3m

# BOX POST SVEZZAMENTO



Box post svezzamento Economico  
(20506200000000)

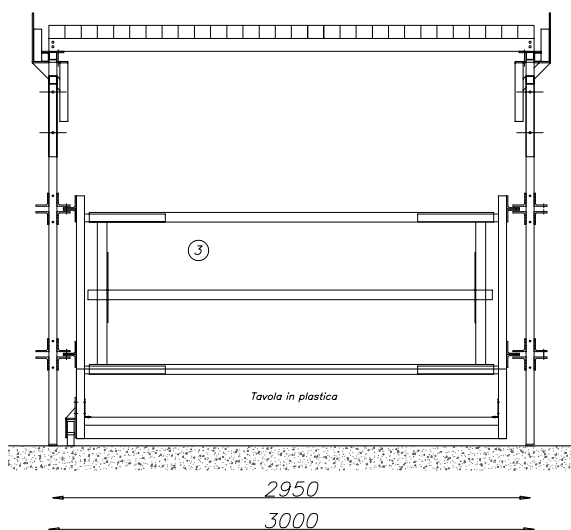
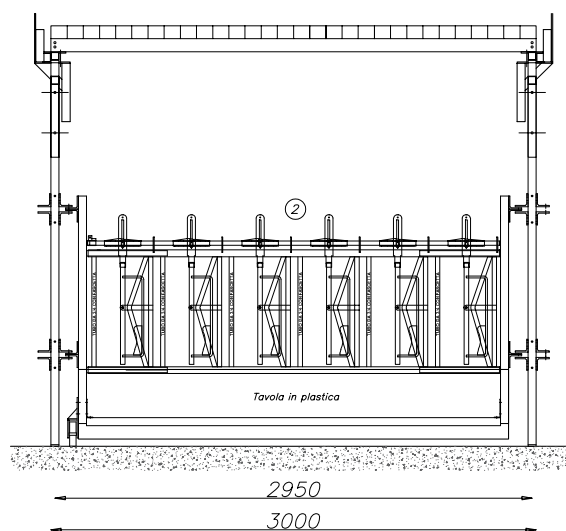
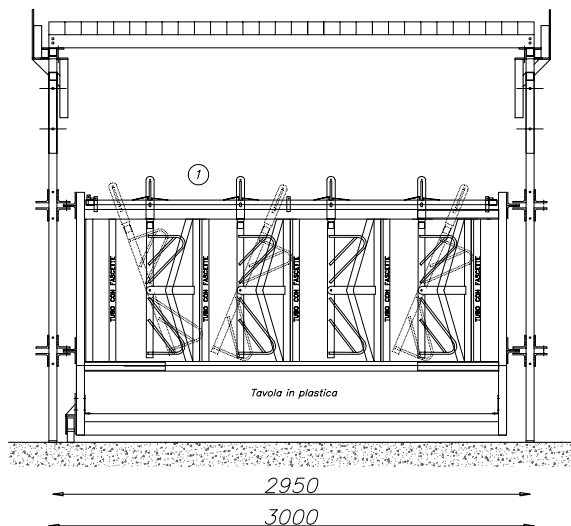

Posizione	Codice	Descrizione
01	205068100004300	Kit con autocattura "Life" 4p/3m eco
02	205068100006300	Kit con autocattura "Baby" 6p/3m eco
03	205068100000600	Kit con tubo testa a cancello 3m eco

# BOX POST SVEZZAMENTO

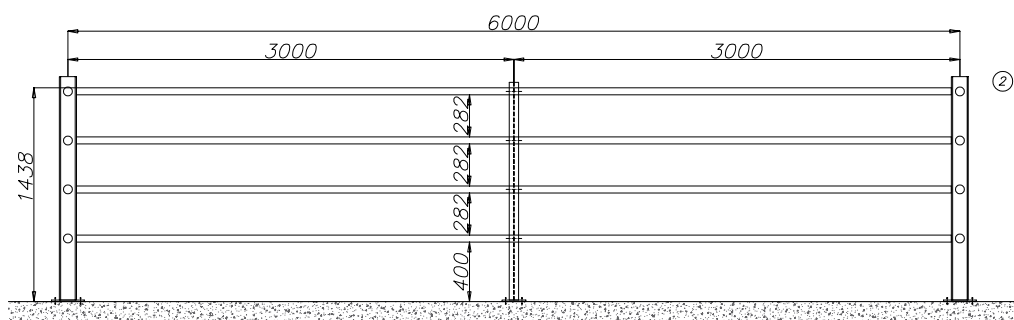
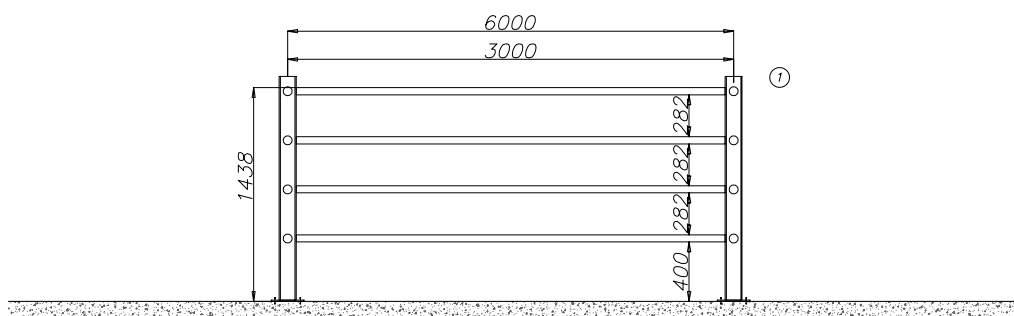
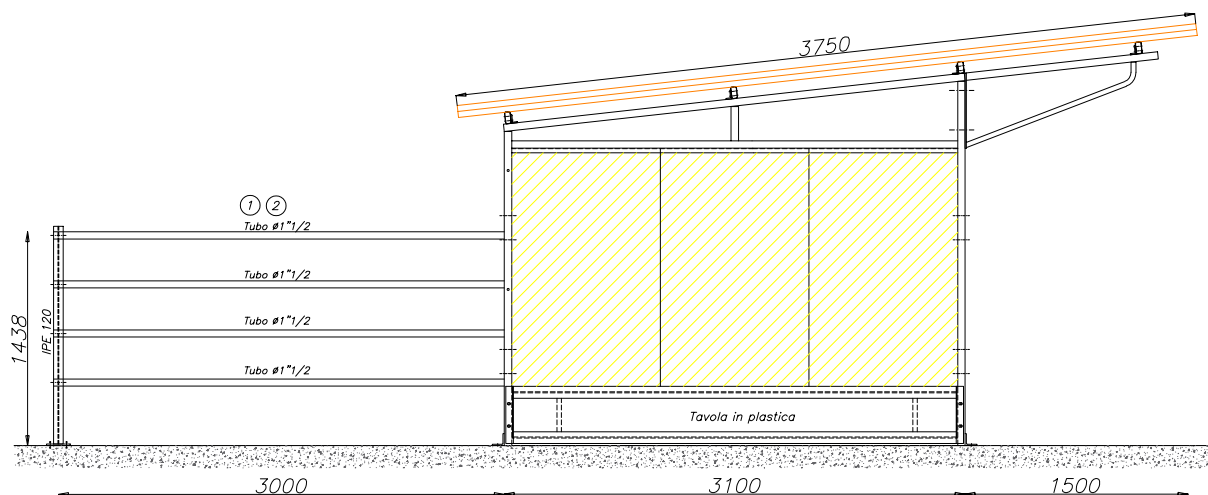

Posizione	Codice	Descrizione
01	205063000300300	Paddock posteriore 3x3m
02	205063000600300	Paddock posteriore 3x6m